

A-1B



kg 11



0,5

SAE.90EP

comer industries
mechatronic solutions

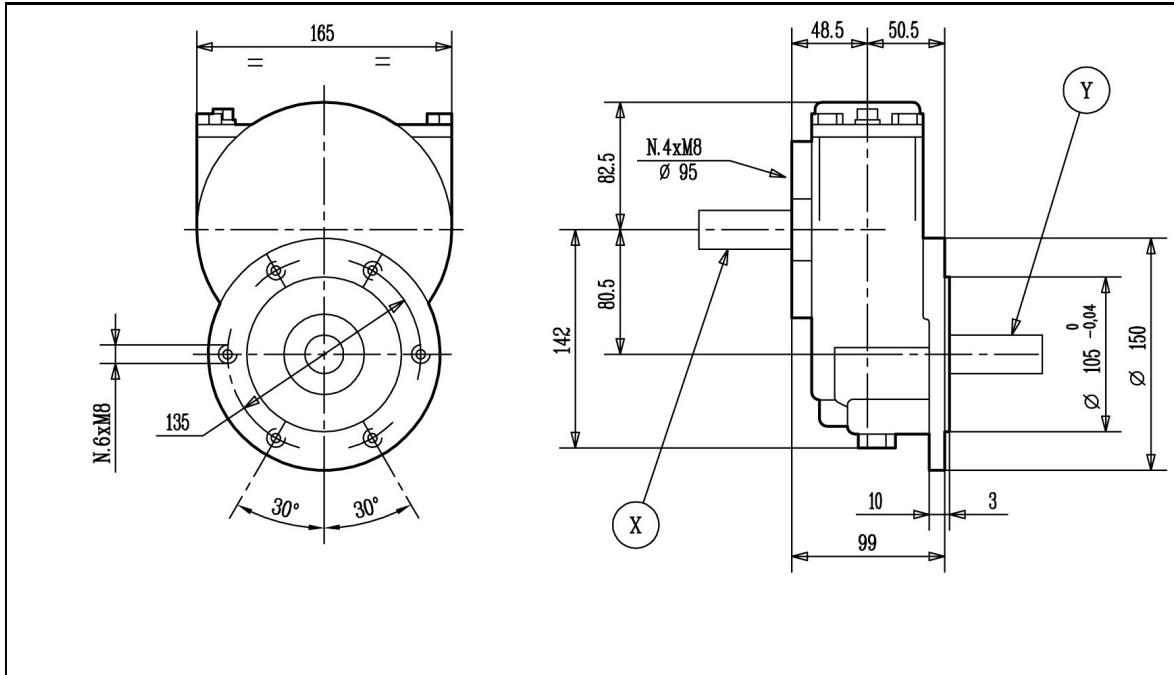



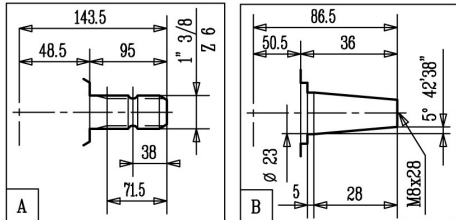



Shaft Profiles - Tipi di Albero



A-1B

Technical Data - Dati Tecnici

															L		
i	r.p.m.	HP	kW	daNm	InLbs	X	Y	Z								comer industries	
1 : 7	429	13	9,6	2,9	273	A	B	-	207	208	-	-	-	0	X	-	600.005