

A-4A



kg 43



1

SAE.90EP

comer industries
mechatronic solutions

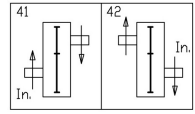
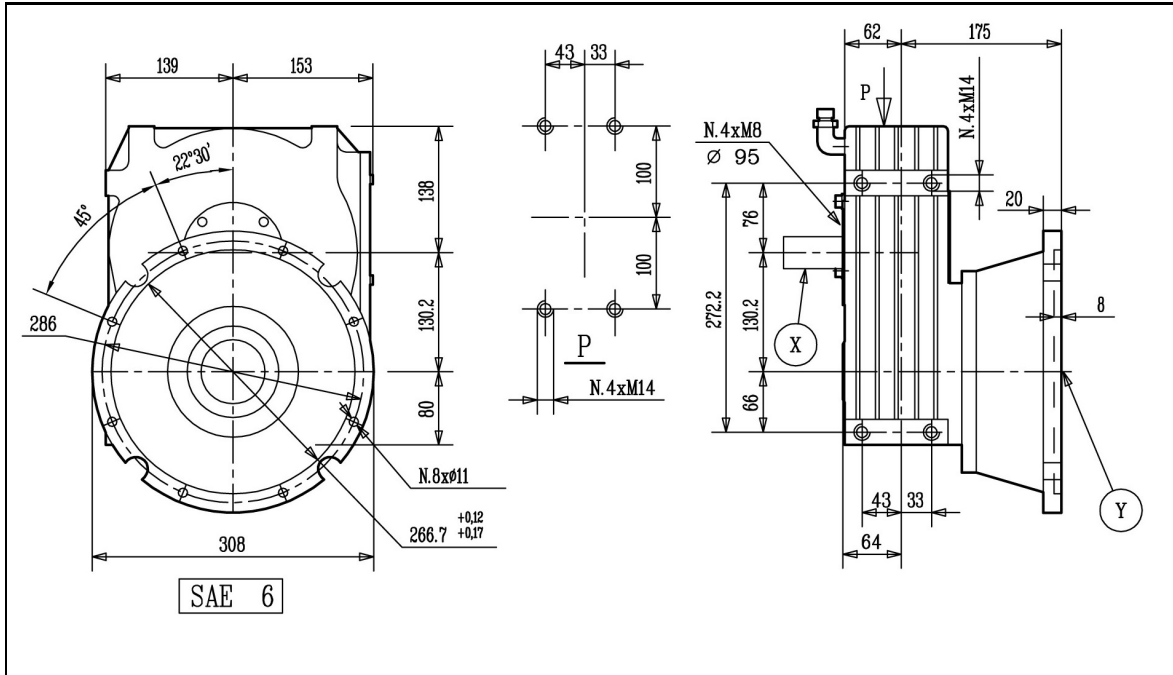



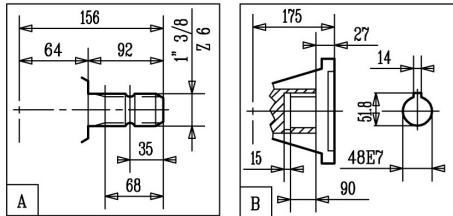



Shaft Profiles - Tipi di Albero



A-4A

Technical Data - Dati Tecnici

															L		
i	r.p.m.	HP	kW	daNm	InLbs	X	Y	Z								comer industries	
1 : 3,8	395	75	55	34	3150	A	B	-	207	208	-	-	-	0	X -	603.341	