

# A-4F



kg 47



1

SAE.90EP

**comer industries**  
mechatronic solutions

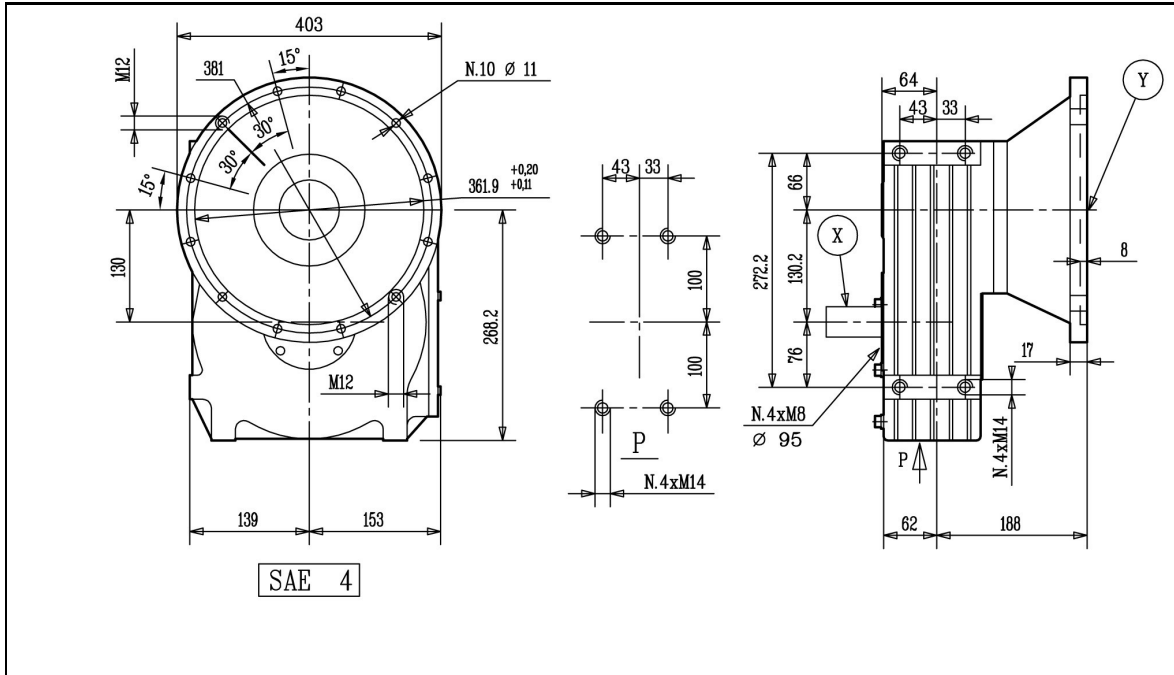



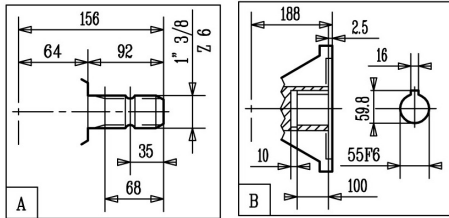



### Shaft Profiles - Tipi di Albero



# A-4F

*Technical Data - Dati Tecnici*

														<b>L</b>		
<b>i</b>	<b>r.p.m.</b>	<b>HP</b>	<b>kW</b>	<b>daNm</b>	<b>InLbs</b>	<b>X</b>	<b>Y</b>	<b>Z</b>								<b>comer industries</b>
1 : 3,8	395	75	55	34	3150	A	B	-	41	42	-	-	-	0	X -	603.347