

A-623A

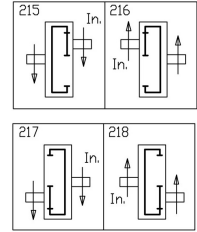

 kg

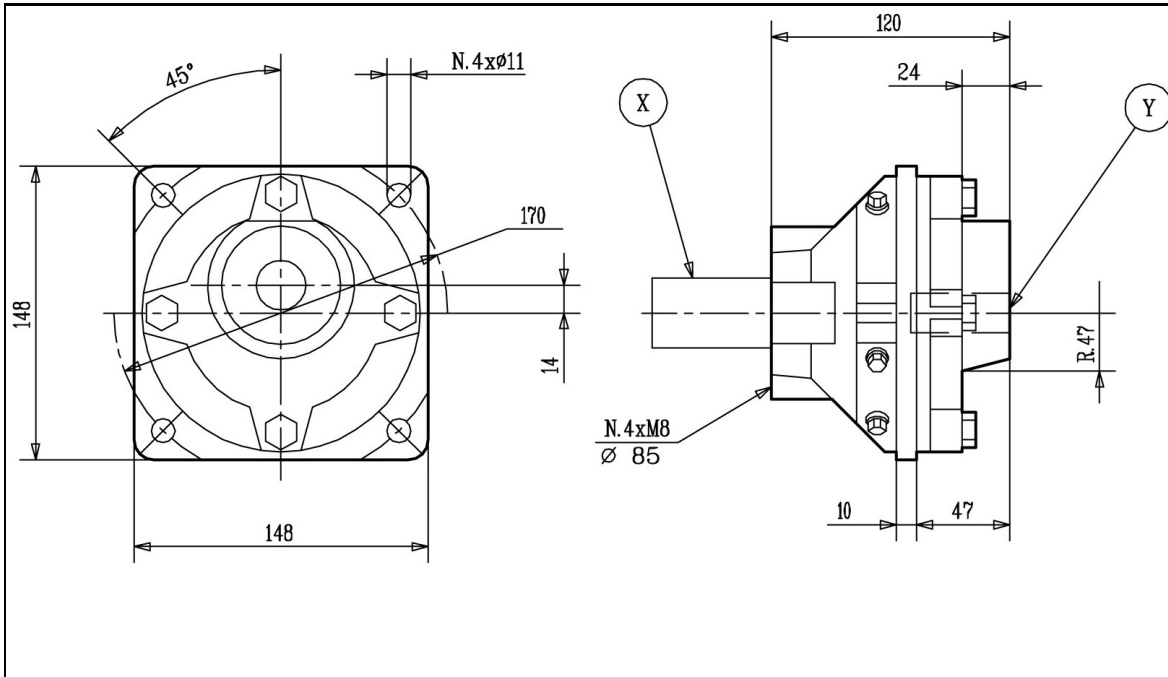



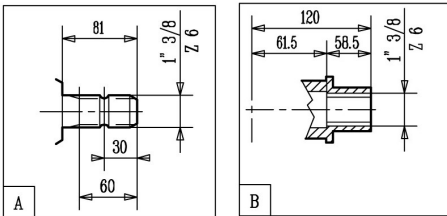

 LT. 0
SAE.90EP

Shaft Profiles - Tipi di Albero



A-623A

Technical Data - Dati Tecnici

															L		
i	r.p.m.	HP	kW	daNm	InLbs	X	Y	Z									comer industries
1 : 1,6	540	15	11	12	1045	A	B	-	217	218	-	-	-	0	X	-	623.000
1,6 : 1	540	10	7,4	20	1789	A	B	-	215	216	-	-	-	0	Y	-	623.000