

A-624F



kg 26



0,5

SAE.90EP

comer industries
mechatronic solutions

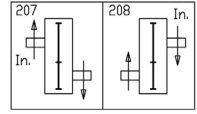
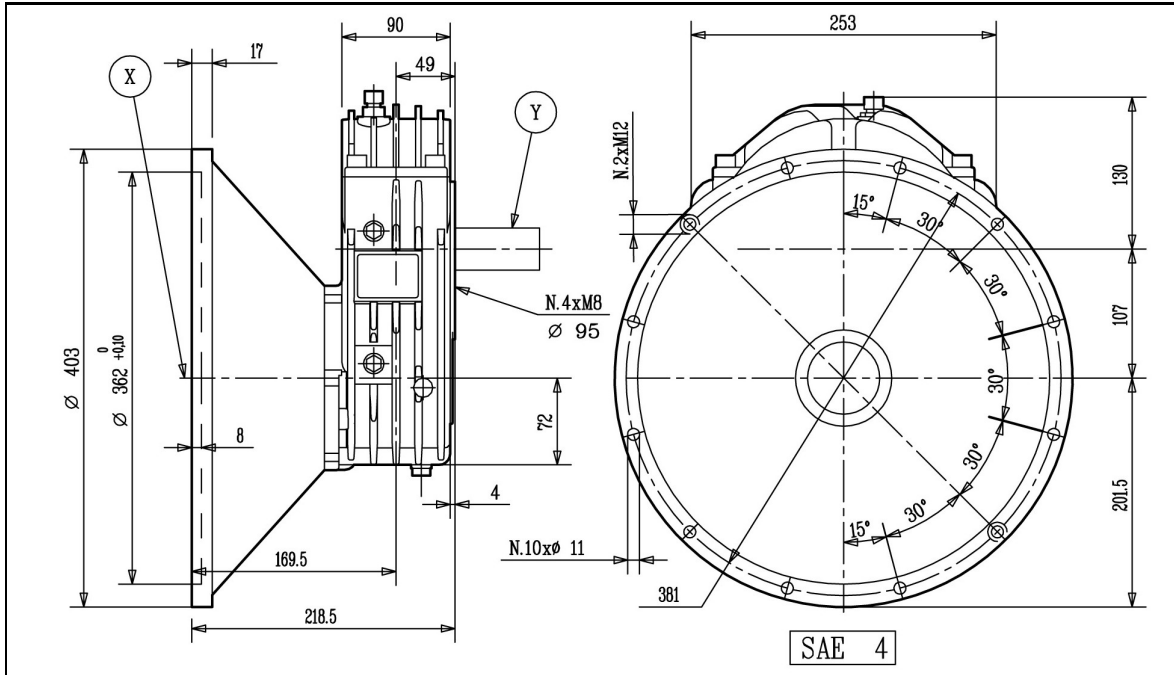



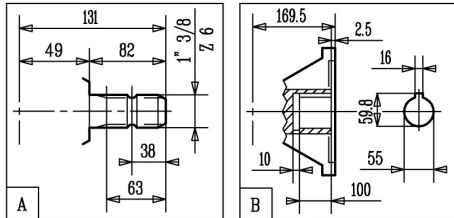



Shaft Profiles - Tipi di Albero



A-624F

Technical Data - Dati Tecnici

															L		
i	r.p.m.	HP	kW	daNm	InLbs	X	Y	Z								comer industries	
1 : 3,5	429	41	30	18,6	1721	B	A	-	207	208	-	-	-	0	Y	-	624.002