

# L-25A



kg 4,1



0,35

SAE.90EP



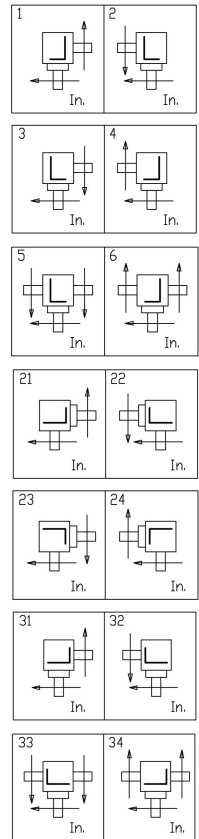
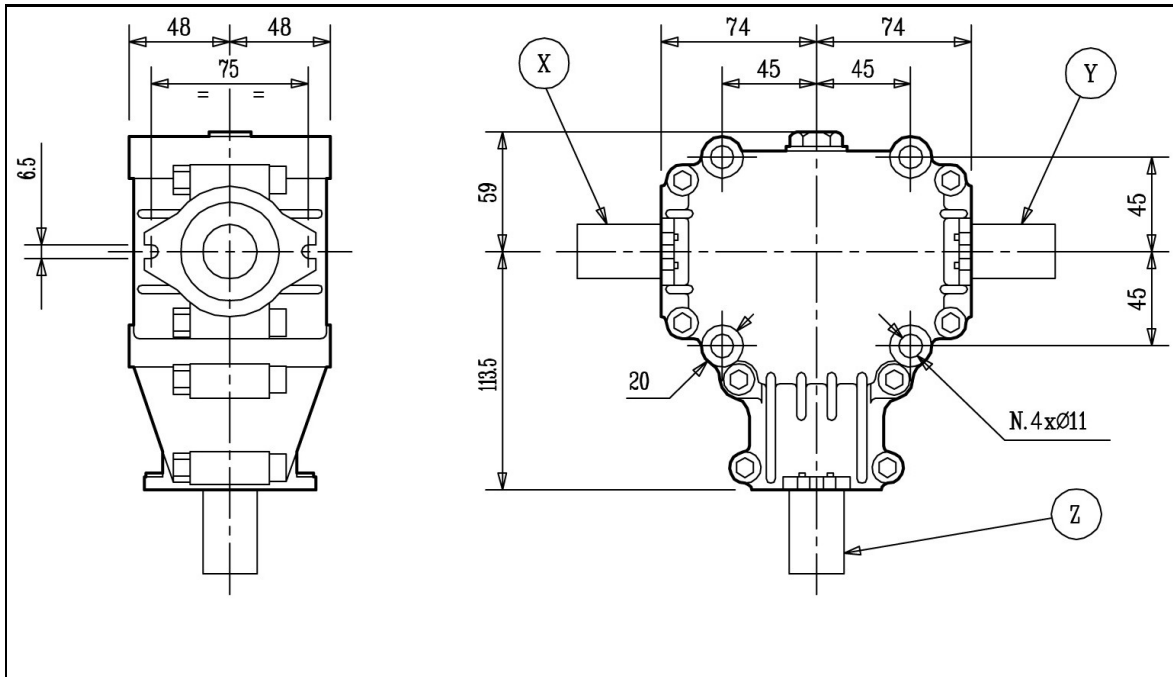

**comer industries**  
mechatronic solutions

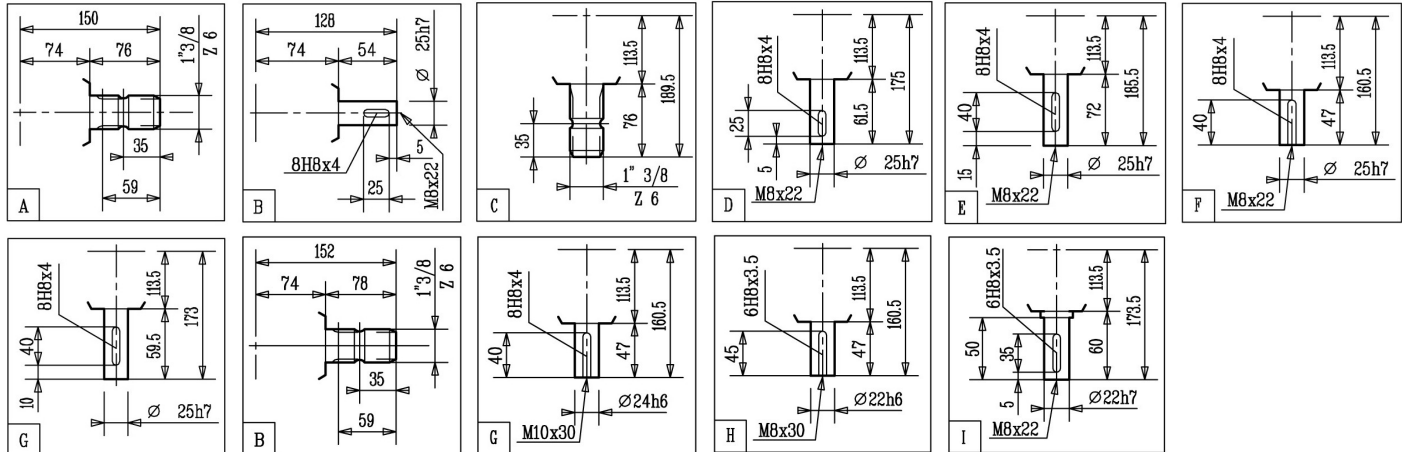

## Shaft Profiles - Tipi di Albero



## Technical Data - Dati Tecnici

i	r.p.m.	HP	kW										L				
				daNm	lnLbs	X	Y	Z	1	2	3	4					
1 : 1	540	15	11	19	1674	B	-	D	1	2	-	-	-	0	Z	-	124.005
1 : 1	540	15	11	19	1674	B	B	D	5	6	-	-	-	0	Z	-	124.006
1 : 1	540	15	11	19	1674	-	B	C	3	4	-	-	-	0	Z	-	124.007
1 : 1	540	15	11	19	1674	B	-	C	1	2	-	-	-	0	Z	-	124.010
1 : 1	540	15	11	19	1674	A	-	C	1	2	-	-	-	0	Z	-	124.012
1 : 1	540	15	11	19	1674	-	B	D	3	4	-	-	-	0	Z	-	124.013
1 : 1	540	15	11	19	1674	B	B	C	5	6	-	-	-	0	Z	-	124.017
1 : 1	540	15	11	19	1674	A	-	C	3	4	-	-	-	0	Z	-	124.037
1 : 1,35	540	13	9,9	12	1072	B	-	D	21	22	-	-	-	0	X	-	124.009
1 : 1,35	540	13	9,9	12	1072	-	B	D	23	24	-	-	-	0	Y	-	124.014
1 : 1,35	540	13	9,9	12	1072	B	-	D	31	32	-	-	-	0	Z	-	124.904
1 : 1,35	540	13	9,9	12	1072	A	-	D	21	22	-	-	-	0	X	-	124.906
1 : 1,35	540	13	9,9	12	1072	-	A	D	23	24	-	-	-	0	Y	-	124.908
1 : 1,9	540	15	11	10	886	B	-	E	21	22	-	-	-	0	X	-	124.004
1 : 1,9	540	15	11	10	886	-	B	E	23	24	-	-	-	0	Y	-	124.019
1 : 1,9	540	15	11	10	886	B	B	D	33	34	-	-	-	0	Z	-	124.032
1 : 1,9	540	15	11	10	886	B	-	C	31	32	-	-	-	0	Z	-	124.320
1 : 1,9	540	15	11	9,9	921	-	H	M	23	24	-	-	-	0	Y	-	124.900
1 : 1,9	540	15	11	10	886	A	-	E	21	22	-	-	-	0	X	-	124.901
1 : 1,9	540	15	11	10	886	-	A	E	23	24	-	-	-	0	Y	-	124.902
1 : 1,9	540	15	11	9,9	921	-	H	M	21	22	-	-	-	0	Y	-	124.903
1 : 1,9	540	15	11	10	886	B	-	D	31	32	-	-	-	0	Z	-	124.910
1 : 1,9	540	15	11	10	886	B	B	C	33	34	-	-	-	0	Z	-	124.912
1 : 2,78	540	7	5,2	3	283	A	-	F	21	22	-	-	-	0	X	-	124.029
1 : 2,78	540	7	5,2	3,1	294	A	-	F	21	22	-	-	-	0	X	-	124.029
1 : 2,78	540	7	5,2	3,1	294	-	A	L	23	24	-	-	-	0	Y	-	124.033
1 : 2,78	540	7	5,2	3,1	294	-	A	L	21	22	-	-	-	0	Y	-	124.034
1 : 2,78	540	7	5,2	3,1	294	-	H	I	23	24	-	-	-	0	Y	-	124.315
1 : 2,78	540	7	5,2	3	283	-	A	F	23	24	-	-	-	0	Y	-	124.913
1,35 : 1	540	11	8,1	19	1656	B	-	D	1	2	-	-	-	0	Z	-	124.009
1,35 : 1	540	11	8,1	19	1656	B	-	C	1	2	-	-	-	0	Z	-	124.011
1,35 : 1	540	11	8,1	19	1656	-	B	D	3	4	-	-	-	0	Z	-	124.014
1,35 : 1	540	11	8,1	19	1656	-	B	C	3	4	-	-	-	0	Z	-	124.015
1,35 : 1	540	11	8,1	19	1656	B	B	D	5	6	-	-	-	0	Z	-	124.016
1,35 : 1	540	11	8,1	19	1656	B	B	C	5	6	-	-	-	0	Z	-	124.018
1,9 : 1	540	10	7	24	2117	B	-	E	1	2	-	-	-	0	Z	-	124.004
1,9 : 1	540	10	7	24	2117	-	B	E	3	4	-	-	-	0	Z	-	124.019
1,9 : 1	540	10	7	24	2117	B	B	E	5	6	-	-	-	0	Z	-	124.020
2,78 : 1	540	4	2,9	14	1240	B	-	F	1	2	-	-	-	0	Z	-	124.021
2,78 : 1	540	4	2,9	14	1240	B	B	F	5	6	-	-	-	0	Z	-	124.022
2,78 : 1	540	4	2,9	14	1240	-	B	F	3	4	-	-	-	0	Z	-	124.104
3,3 : 1	540	3	2,2	12	1107	B	B	G	5	6	-	-	-	0	Z	-	124.111